

Deflection gear 3045

Description

Bevel gearbox for the deflection of a rotary movement at an angle of 90°. The gearbox can be supplied both with a hexagonal axle with a specific length or without an axle. Simple mounting is made possible by a flexible screw fixing.

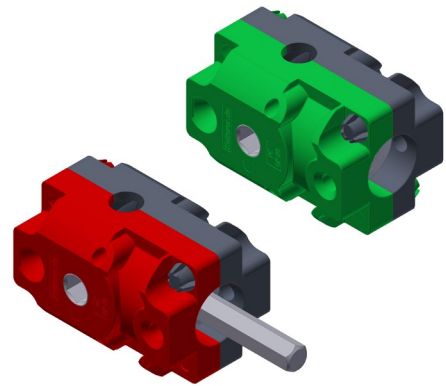

Special features

- Maintenance-free
- Case-hardened steel bevel wheels
- Synthetic gear housing
- Ratio 1 : 1 (red-black) and 2 : 1 (green-black)
- Suitable for both manual and electric motor drives



Variant key

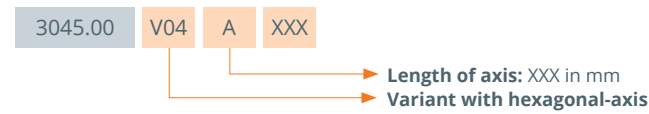

Technical data

Model	3045.00-3001	3045.00-3002	3045.00-V04AXXX
Ratio	1:1	2:1*	1:1
Input/Output	hex 6 mm	hex 6 mm	hex 6 mm
Number of bevel wheels	2	2	2
Max. drive torque	5,5 Nm	5,5 Nm	5,5 Nm
Length A	-	-	Customer specific
Housing material	Synthetic	Synthetic	Synthetic

* Input to output

3045.00-3001 - Ratio 1:1

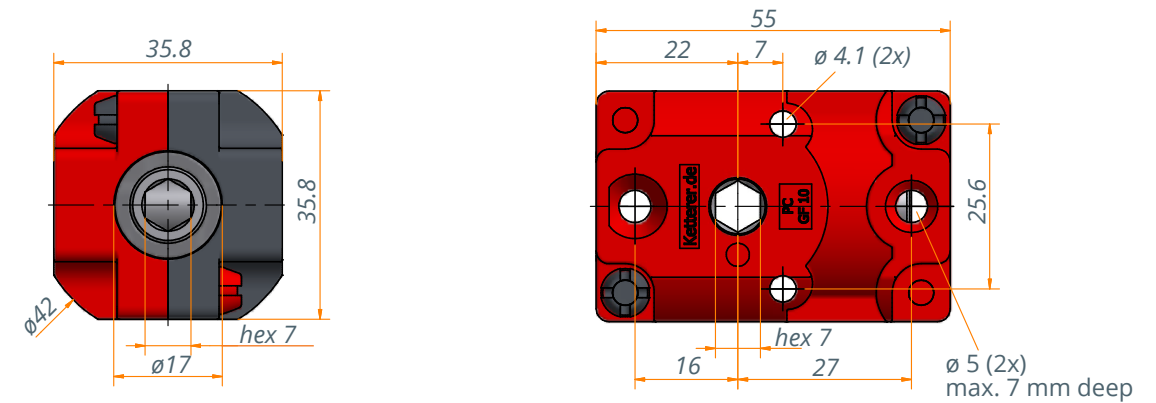

3045.00-3002 - Ratio 2:1 (Input : Output)

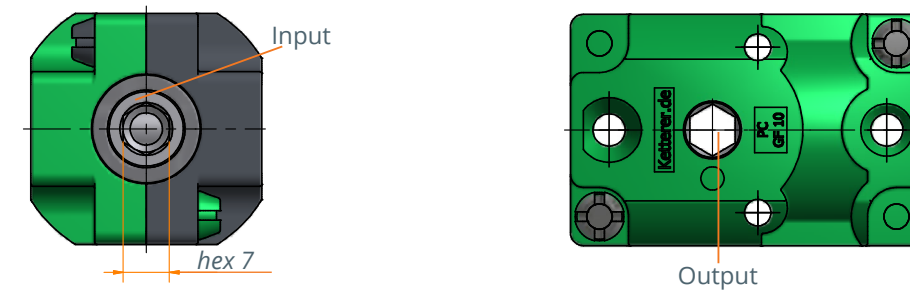

3045.00-V04AXXX - Ratio 1:1

