

Electric spindle drive 4640

Description

Motorized solution for sit-stand workplace. Stepless height adjustment to customer specific travel distance.

Special features

- Simple mounting
- Integrated position measuring system
- Single telescopic function
- Synchronisation with up to 26 actuators
- Various spindle lengths and different spindle pitches are possible



Technical data

Model	4640.00-V01EXXXHXXX
Motor	DC Motor 24 V
Sensor/Power supply	Hall/5 V DC/0.3 A
Protection class	IP30
Duty cycle	20% (at 5 min.)
Idle running speed	100 rpm (24 V) 150 rpm *
Max. stroke	Retracted length -107 mm
Type of spindle	SG14x16P4 RH **
Max. lifting force	800 N
Max. drive torque	5 Nm
Movement speed	40 mm/s

* In combination with LogicData control box Compact-3

** Further types of spindles on request

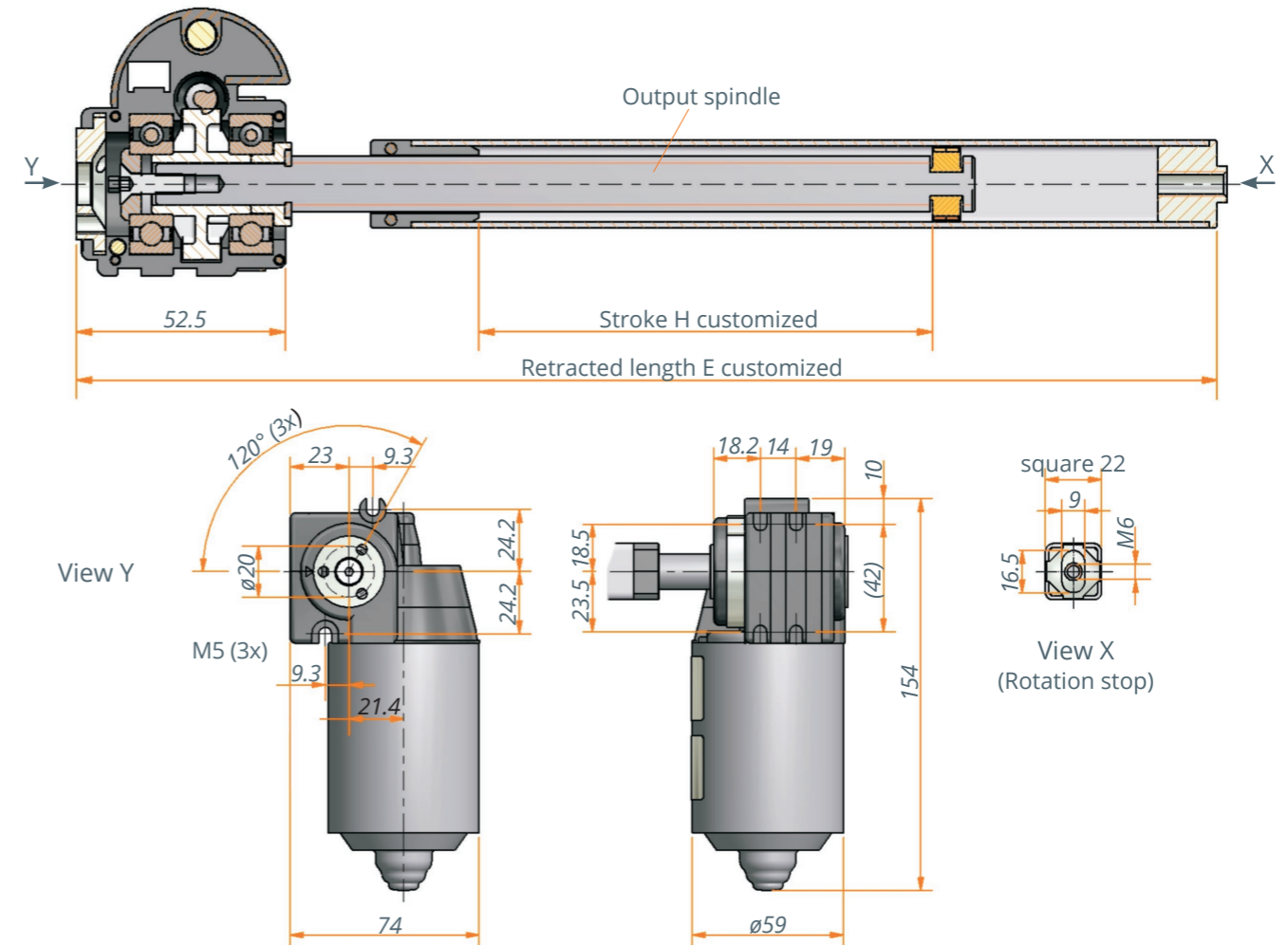

Technical notes

- Depending on the the spindle pitch, the system could back-drive.

Application example

